

Check Modular Valves

Specifications

Model Numbers	Max. Operating Pressure MPa	Max. Flow L/min
MC *-01- *-70	35	60

Model Number Designation

MCP	-01	-0	-70
Series Number	Valve Size	Cracking Pressure MPa	Design Number
MCP: Check Valve for P-Line MCA: Check Valve for A-Line MCB: Check Valve for B-Line MCT: Check Valve for T-Line MCW: Check Valve for A-Line & B-Line	01	0: 0.035 2: 0.2 4: 0.4	70

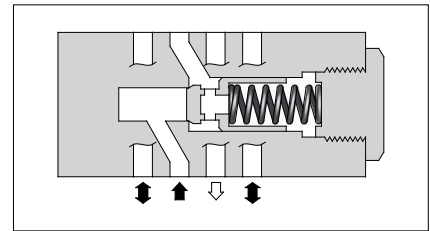
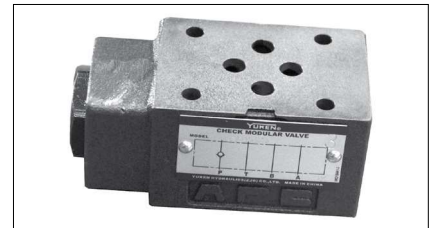

Graphic Symbols

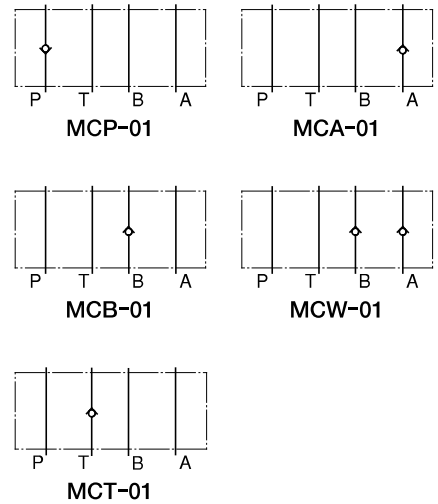

Typical Performance Characteristics

Hydraulic Fluid: Viscosity 35 mm²/s, Specific Gravity 0.850

Pressure Drop for Free Flow

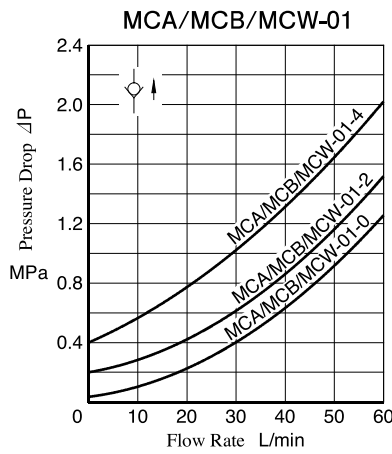
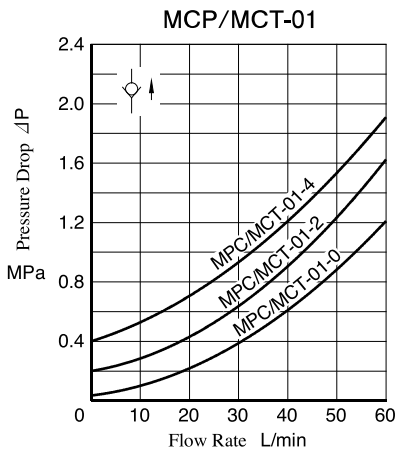

Pressure Drop of each line

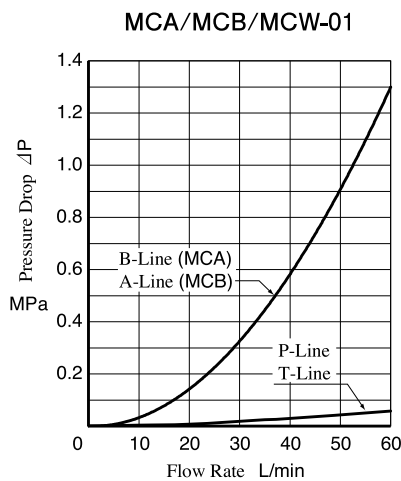
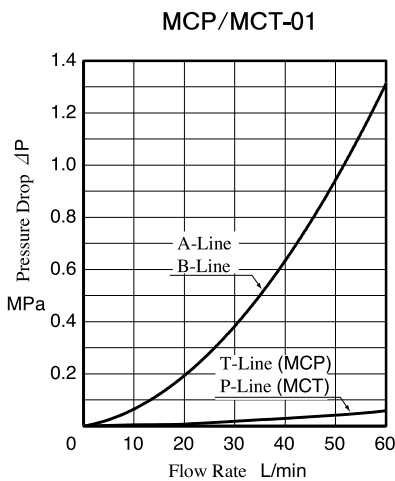

01 Series Modular Valves

**MCA-01
MCB-01
MCW-01**

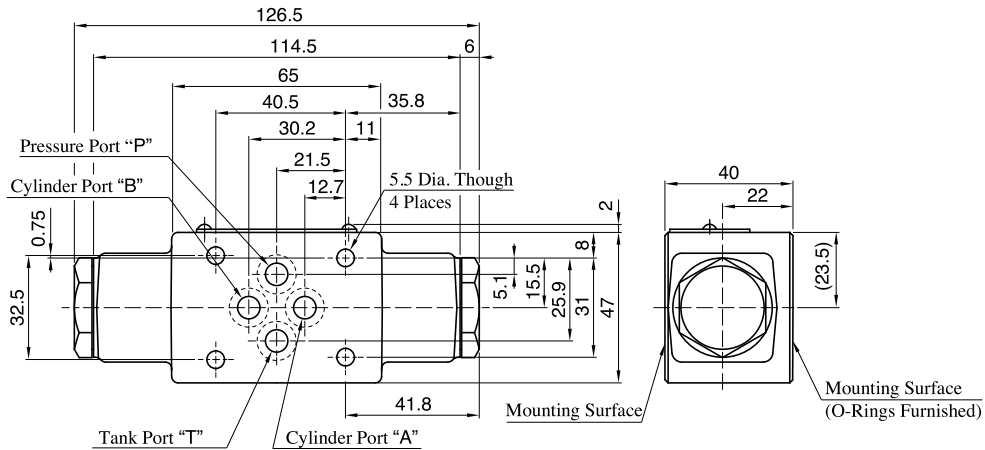

Approx. Mass.....1.2 kg

MCP-01

MCT-01

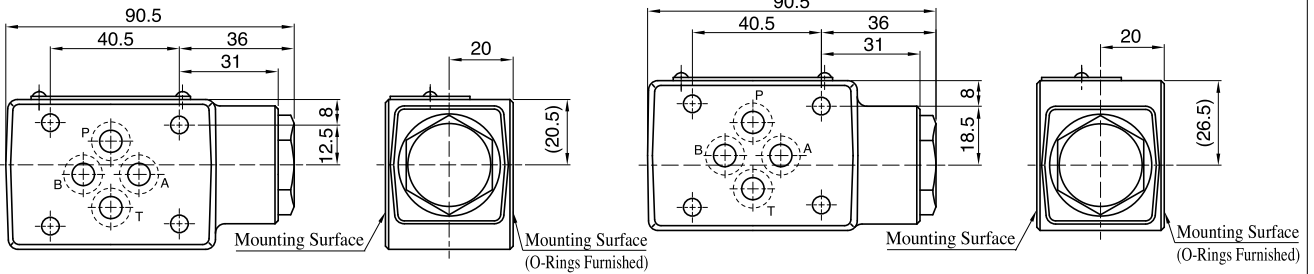

● Please refer to the drawing above (MCA-01/MCB-01/MCW-01) for other dimensions. Approx. Mass.....1.0 kg

List of Seals

**MCP-01
MCT-01**

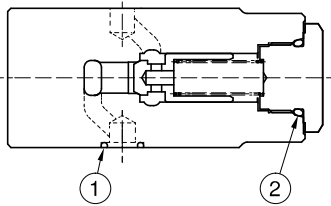

Item	Name of Parts	Part Numbers	Qty.
1	O-Ring	OR NBR-90 P9-N	4
2	O-Ring	OR NBR-90 P18-N	1

**MCA-01
MCB-01
MCW-01**

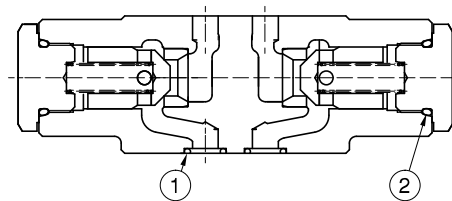

Please refer to the drawing above for MCW-01.

- MCA-01 does not have poppet, spring or seat built in the left side.
- MCB-01 does not have poppet, spring or seat built in the right side.

Item	Name of Parts	Model of Parts	Qty.
1	O-Ring	OR NBR-90 P9-N	4
2	O-Ring	OR NBR-90 P18-N	2